

Contextual Semantics:
From Quantum Mechanics to Logic, Databases,
Constraints, and Complexity
Lecture 1

Samson Abramsky

Department of Computer Science
The University of Oxford

Beginnings ...

Beginnings ...

The first axiom I learnt in Computer Science:

Beginnings ...

The first axiom I learnt in Computer Science:

Computers might as well be made of green cheese

Beginnings ...

The first axiom I learnt in Computer Science:

Computers might as well be made of green cheese



Beginnings ...

The first axiom I learnt in Computer Science:

Computers might as well be made of green cheese



It is no longer safe to assume this!

Some Agendas for Quantum Computer Science

Some Agendas for Quantum Computer Science

- Information processing systems are **physically embodied**. The underlying physics is ultimately **quantum-mechanical**. Taking this seriously forces us to re-examine many of our basic assumptions about Computer Science.

Some Agendas for Quantum Computer Science

- Information processing systems are **physically embodied**. The underlying physics is ultimately **quantum-mechanical**. Taking this seriously forces us to re-examine many of our basic assumptions about Computer Science.
- It has already led to some exciting developments: remarkable new algorithms, cryptographic schemes, and basic questions in computational complexity.

Some Agendas for Quantum Computer Science

- Information processing systems are **physically embodied**. The underlying physics is ultimately **quantum-mechanical**. Taking this seriously forces us to re-examine many of our basic assumptions about Computer Science.
- It has already led to some exciting developments: remarkable new algorithms, cryptographic schemes, and basic questions in computational complexity.
- Beyond algorithms and complexity it offers new challenges and opportunities across the range of Computer Science: in programming languages and methods, logic and semantics.

Some Agendas for Quantum Computer Science

- Information processing systems are **physically embodied**. The underlying physics is ultimately **quantum-mechanical**. Taking this seriously forces us to re-examine many of our basic assumptions about Computer Science.
- It has already led to some exciting developments: remarkable new algorithms, cryptographic schemes, and basic questions in computational complexity.
- Beyond algorithms and complexity it offers new challenges and opportunities across the range of Computer Science: in programming languages and methods, logic and semantics.
- There is a fascinating two-way interplay developing between Computer Science and Physics, extending to the foundations of both, as well as to more practical matters. Quantum technology — “hacking matter” — will be a huge feature of 21st Century science and engineering, and a lot of it will be to do with information.

Some Agendas for Quantum Computer Science

- Information processing systems are **physically embodied**. The underlying physics is ultimately **quantum-mechanical**. Taking this seriously forces us to re-examine many of our basic assumptions about Computer Science.
- It has already led to some exciting developments: remarkable new algorithms, cryptographic schemes, and basic questions in computational complexity.
- Beyond algorithms and complexity it offers new challenges and opportunities across the range of Computer Science: in programming languages and methods, logic and semantics.
- There is a fascinating two-way interplay developing between Computer Science and Physics, extending to the foundations of both, as well as to more practical matters. Quantum technology — “hacking matter” — will be a huge feature of 21st Century science and engineering, and a lot of it will be to do with information.
- This is an exciting emerging area, attracting students with backgrounds in CS, Physics, Mathematics, Philosophy, ...

Contextual Semantics

Contextual Semantics

- At the heart of quantum non-classicality are the phenomena of **non-locality**, **contextuality** and **entanglement**.

Contextual Semantics

- At the heart of quantum non-classicality are the phenomena of **non-locality**, **contextuality** and **entanglement**.
- These concepts play a central rôle in the rapidly developing field of quantum information, in delineating how quantum resources can transcend the bounds of classical information processing.

Contextual Semantics

- At the heart of quantum non-classicality are the phenomena of **non-locality**, **contextuality** and **entanglement**.
- These concepts play a central rôle in the rapidly developing field of quantum information, in delineating how quantum resources can transcend the bounds of classical information processing.
- They also have profound consequences for our understanding of the very nature of physical reality.

Contextual Semantics

- At the heart of quantum non-classicality are the phenomena of **non-locality**, **contextuality** and **entanglement**.
- These concepts play a central rôle in the rapidly developing field of quantum information, in delineating how quantum resources can transcend the bounds of classical information processing.
- They also have profound consequences for our understanding of the very nature of physical reality.
- We shall describe recent work in which tools from Computer Science are used to shed new light on these phenomena.

Contextual Semantics

- At the heart of quantum non-classicality are the phenomena of **non-locality**, **contextuality** and **entanglement**.
- These concepts play a central rôle in the rapidly developing field of quantum information, in delineating how quantum resources can transcend the bounds of classical information processing.
- They also have profound consequences for our understanding of the very nature of physical reality.
- We shall describe recent work in which tools from Computer Science are used to shed new light on these phenomena.
- There are also striking and unexpected connections with a number of topics in **classical** computer science, including relational databases and constraint satisfaction.

Contextual Semantics

- At the heart of quantum non-classicality are the phenomena of **non-locality**, **contextuality** and **entanglement**.
- These concepts play a central rôle in the rapidly developing field of quantum information, in delineating how quantum resources can transcend the bounds of classical information processing.
- They also have profound consequences for our understanding of the very nature of physical reality.
- We shall describe recent work in which tools from Computer Science are used to shed new light on these phenomena.
- There are also striking and unexpected connections with a number of topics in **classical** computer science, including relational databases and constraint satisfaction.
- So, let's go right to the heart of the quantum mystery . . .

Alice and Bob look at bits

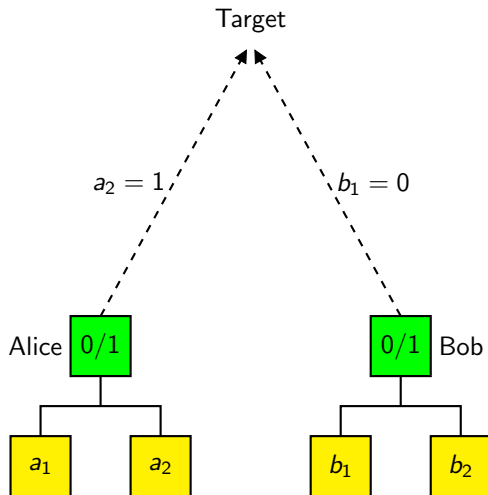

A Probabilistic Model Of An Experiment

A Probabilistic Model Of An Experiment

Example: The Bell Model

A	B	(0,0)	(1,0)	(0,1)	(1,1)
a_1	b_1	$1/2$	0	0	$1/2$
a_1	b_2	$3/8$	$1/8$	$1/8$	$3/8$
a_2	b_1	$3/8$	$1/8$	$1/8$	$3/8$
a_2	b_2	$1/8$	$3/8$	$3/8$	$1/8$

A Probabilistic Model Of An Experiment

Example: The Bell Model

A	B	(0, 0)	(1, 0)	(0, 1)	(1, 1)
a_1	b_1	$1/2$	0	0	$1/2$
a_1	b_2	$3/8$	$1/8$	$1/8$	$3/8$
a_2	b_1	$3/8$	$1/8$	$1/8$	$3/8$
a_2	b_2	$1/8$	$3/8$	$3/8$	$1/8$

The entry in row 2 column 3 says:

If Alice looks at a_1 and Bob looks at b_2 , then 1/8th of the time, Alice sees a 0 and Bob sees a 1.

A Probabilistic Model Of An Experiment

Example: The Bell Model

A	B	(0, 0)	(1, 0)	(0, 1)	(1, 1)
a_1	b_1	$1/2$	0	0	$1/2$
a_1	b_2	$3/8$	$1/8$	$1/8$	$3/8$
a_2	b_1	$3/8$	$1/8$	$1/8$	$3/8$
a_2	b_2	$1/8$	$3/8$	$3/8$	$1/8$

The entry in row 2 column 3 says:

If Alice looks at a_1 and Bob looks at b_2 , then $1/8$ th of the time, Alice sees a 0 and Bob sees a 1.

How can we explain this behaviour?

Classical Correlations

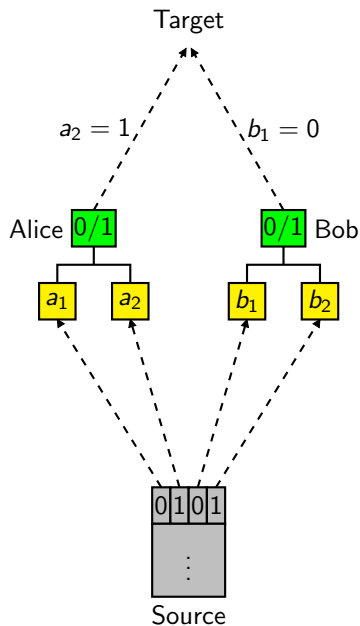

A Simple Observation

A Simple Observation

Suppose we have propositional formulas ϕ_1, \dots, ϕ_N

A Simple Observation

Suppose we have propositional formulas ϕ_1, \dots, ϕ_N

Suppose further we can assign a probability $p_i = \text{Prob}(\phi_i)$ to each ϕ_i .

A Simple Observation

Suppose we have propositional formulas ϕ_1, \dots, ϕ_N

Suppose further we can assign a probability $p_i = \text{Prob}(\phi_i)$ to each ϕ_i .

(Story: perform experiment to test the variables in ϕ_i ; p_i is the relative frequency of the trials satisfying ϕ_i .)

A Simple Observation

Suppose we have propositional formulas ϕ_1, \dots, ϕ_N

Suppose further we can assign a probability $p_i = \text{Prob}(\phi_i)$ to each ϕ_i .

(Story: perform experiment to test the variables in ϕ_i ; p_i is the relative frequency of the trials satisfying ϕ_i .)

Suppose that these formulas are **not simultaneously satisfiable**. Then (e.g.)

$$\bigwedge_{i=1}^{N-1} \phi_i \rightarrow \neg \phi_N,$$

A Simple Observation

Suppose we have propositional formulas ϕ_1, \dots, ϕ_N

Suppose further we can assign a probability $p_i = \text{Prob}(\phi_i)$ to each ϕ_i .

(Story: perform experiment to test the variables in ϕ_i ; p_i is the relative frequency of the trials satisfying ϕ_i .)

Suppose that these formulas are **not simultaneously satisfiable**. Then (e.g.)

$$\bigwedge_{i=1}^{N-1} \phi_i \rightarrow \neg\phi_N, \quad \text{or equivalently} \quad \phi_N \rightarrow \bigvee_{i=1}^{N-1} \neg\phi_i.$$

A Simple Observation

Suppose we have propositional formulas ϕ_1, \dots, ϕ_N

Suppose further we can assign a probability $p_i = \text{Prob}(\phi_i)$ to each ϕ_i .

(Story: perform experiment to test the variables in ϕ_i ; p_i is the relative frequency of the trials satisfying ϕ_i .)

Suppose that these formulas are **not simultaneously satisfiable**. Then (e.g.)

$$\bigwedge_{i=1}^{N-1} \phi_i \rightarrow \neg\phi_N, \quad \text{or equivalently} \quad \phi_N \rightarrow \bigvee_{i=1}^{N-1} \neg\phi_i.$$

Using elementary probability theory, we can calculate:

$$p_N \leq \text{Prob}\left(\bigvee_{i=1}^{N-1} \neg\phi_i\right) \leq \sum_{i=1}^{N-1} \text{Prob}(\neg\phi_i) = \sum_{i=1}^{N-1} (1 - p_i) = (N-1) - \sum_{i=1}^{N-1} p_i.$$

A Simple Observation

Suppose we have propositional formulas ϕ_1, \dots, ϕ_N

Suppose further we can assign a probability $p_i = \text{Prob}(\phi_i)$ to each ϕ_i .

(Story: perform experiment to test the variables in ϕ_i ; p_i is the relative frequency of the trials satisfying ϕ_i .)

Suppose that these formulas are **not simultaneously satisfiable**. Then (e.g.)

$$\bigwedge_{i=1}^{N-1} \phi_i \rightarrow \neg \phi_N, \quad \text{or equivalently} \quad \phi_N \rightarrow \bigvee_{i=1}^{N-1} \neg \phi_i.$$

Using elementary probability theory, we can calculate:

$$p_N \leq \text{Prob}\left(\bigvee_{i=1}^{N-1} \neg \phi_i\right) \leq \sum_{i=1}^{N-1} \text{Prob}(\neg \phi_i) = \sum_{i=1}^{N-1} (1 - p_i) = (N-1) - \sum_{i=1}^{N-1} p_i.$$

Hence we obtain the inequality

$$\sum_{i=1}^N p_i \leq N - 1.$$

Logical analysis of the Bell table

Logical analysis of the Bell table

	(0, 0)	(1, 0)	(0, 1)	(1, 1)
(a, b)	1/2	0	0	1/2
(a, b')	3/8	1/8	1/8	3/8
(a', b)	3/8	1/8	1/8	3/8
(a', b')	1/8	3/8	3/8	1/8

Logical analysis of the Bell table

	(0, 0)	(1, 0)	(0, 1)	(1, 1)
(a, b)	1/2	0	0	1/2
(a, b')	3/8	1/8	1/8	3/8
(a', b)	3/8	1/8	1/8	3/8
(a', b')	1/8	3/8	3/8	1/8

If we read 0 as true and 1 as false, the highlighted positions in each row of the table are represented by the following propositions:

$$\varphi_1 = a \wedge b \vee \neg a \wedge \neg b = a \leftrightarrow b$$

$$\varphi_2 = a \wedge b' \vee \neg a \wedge \neg b' = a \leftrightarrow b'$$

$$\varphi_3 = a' \wedge b \vee \neg a' \wedge \neg b = a' \leftrightarrow b$$

$$\varphi_4 = \neg a' \wedge b' \vee a' \wedge \neg b' = a' \oplus b'.$$

Logical analysis of the Bell table

	(0, 0)	(1, 0)	(0, 1)	(1, 1)
(a, b)	1/2	0	0	1/2
(a, b')	3/8	1/8	1/8	3/8
(a', b)	3/8	1/8	1/8	3/8
(a', b')	1/8	3/8	3/8	1/8

If we read 0 as true and 1 as false, the highlighted positions in each row of the table are represented by the following propositions:

$$\varphi_1 = a \wedge b \vee \neg a \wedge \neg b = a \leftrightarrow b$$

$$\varphi_2 = a \wedge b' \vee \neg a \wedge \neg b' = a \leftrightarrow b'$$

$$\varphi_3 = a' \wedge b \vee \neg a' \wedge \neg b = a' \leftrightarrow b$$

$$\varphi_4 = \neg a' \wedge b' \vee a' \wedge \neg b' = a' \oplus b'.$$

These propositions are easily seen to be contradictory.

Logical analysis of the Bell table

	(0, 0)	(1, 0)	(0, 1)	(1, 1)
(a, b)	1/2	0	0	1/2
(a, b')	3/8	1/8	1/8	3/8
(a', b)	3/8	1/8	1/8	3/8
(a', b')	1/8	3/8	3/8	1/8

If we read 0 as true and 1 as false, the highlighted positions in each row of the table are represented by the following propositions:

$$\varphi_1 = a \wedge b \vee \neg a \wedge \neg b = a \leftrightarrow b$$

$$\varphi_2 = a \wedge b' \vee \neg a \wedge \neg b' = a \leftrightarrow b'$$

$$\varphi_3 = a' \wedge b \vee \neg a' \wedge \neg b = a' \leftrightarrow b$$

$$\varphi_4 = \neg a' \wedge b' \vee a' \wedge \neg b' = a' \oplus b'.$$

These propositions are easily seen to be contradictory.

The violation of the logical Bell inequality is 1/4.

Example: the Hardy model

The support of the Hardy model:

	(0,0)	(1,0)	(0,1)	(1,1)
(a,b)	1	1	1	1
(a',b)	0	1	1	1
(a,b')	0	1	1	1
(a',b')	1	1	1	0

Example: the Hardy model

The support of the Hardy model:

	(0,0)	(1,0)	(0,1)	(1,1)
(a,b)	1	1	1	1
(a',b)	0	1	1	1
(a,b')	0	1	1	1
(a',b')	1	1	1	0

If we interpret outcome 0 as true and 1 as false, then the following formulas all have positive probability:

$$a \wedge b, \quad \neg(a \wedge b'), \quad \neg(a' \wedge b), \quad a' \vee b'.$$

Example: the Hardy model

The support of the Hardy model:

	(0,0)	(1,0)	(0,1)	(1,1)
(a,b)	1	1	1	1
(a',b)	0	1	1	1
(a,b')	0	1	1	1
(a',b')	1	1	1	0

If we interpret outcome 0 as true and 1 as false, then the following formulas all have positive probability:

$$a \wedge b, \quad \neg(a \wedge b'), \quad \neg(a' \wedge b), \quad a' \vee b'.$$

However, these formulas are not simultaneously satisfiable.

Example: the Hardy model

The support of the Hardy model:

	(0, 0)	(1, 0)	(0, 1)	(1, 1)
(a, b)	1	1	1	1
(a', b)	0	1	1	1
(a, b')	0	1	1	1
(a', b')	1	1	1	0

If we interpret outcome 0 as true and 1 as false, then the following formulas all have positive probability:

$$a \wedge b, \quad \neg(a \wedge b'), \quad \neg(a' \wedge b), \quad a' \vee b'.$$

However, these formulas are not simultaneously satisfiable.

In this model, $p_2 = p_3 = p_4 = 1$.

Example: the Hardy model

The support of the Hardy model:

	(0, 0)	(1, 0)	(0, 1)	(1, 1)
(a, b)	1	1	1	1
(a', b)	0	1	1	1
(a, b')	0	1	1	1
(a', b')	1	1	1	0

If we interpret outcome 0 as true and 1 as false, then the following formulas all have positive probability:

$$a \wedge b, \quad \neg(a \wedge b'), \quad \neg(a' \wedge b), \quad a' \vee b'.$$

However, these formulas are not simultaneously satisfiable.

In this model, $p_2 = p_3 = p_4 = 1$.

Hence the Hardy model achieves a violation of $p_1 = \text{Prob}(a \wedge b)$ for the logical Bell inequality.

Example: the Hardy model

The support of the Hardy model:

	(0, 0)	(1, 0)	(0, 1)	(1, 1)
(a, b)	1	1	1	1
(a', b)	0	1	1	1
(a, b')	0	1	1	1
(a', b')	1	1	1	0

If we interpret outcome 0 as true and 1 as false, then the following formulas all have positive probability:

$$a \wedge b, \quad \neg(a \wedge b'), \quad \neg(a' \wedge b), \quad a' \vee b'.$$

However, these formulas are not simultaneously satisfiable.

In this model, $p_2 = p_3 = p_4 = 1$.

Hence the Hardy model achieves a violation of $p_1 = \text{Prob}(a \wedge b)$ for the logical Bell inequality.

Quantum Mechanics changes the game

Quantum Mechanics changes the game

It seems then that the kind of behaviour exhibited in these tables is not realisable.

Quantum Mechanics changes the game

It seems then that the kind of behaviour exhibited in these tables is not realisable.
However, if we use **quantum** rather than classical resources, it **is** realisable!

Quantum Mechanics changes the game

It seems then that the kind of behaviour exhibited in these tables is not realisable.

However, if we use **quantum** rather than classical resources, it **is** realisable!

More specifically, if we use an **entangled qubit** as a shared resource between Alice and Bob, who may be spacelike separated, then behaviour of exactly the kind we have considered **can** be achieved.

Quantum Mechanics changes the game

It seems then that the kind of behaviour exhibited in these tables is not realisable.

However, if we use **quantum** rather than classical resources, it **is** realisable!

More specifically, if we use an **entangled qubit** as a shared resource between Alice and Bob, who may be spacelike separated, then behaviour of exactly the kind we have considered **can** be achieved.

Alice and Bob's choices are now of **measurement setting** (e.g. which direction to measure spin) rather than “which register to load”.

The Quantum Case: Spin Measurements

The Quantum Case: Spin Measurements

States of the system can be described by complex unit vectors in \mathbb{C}^2 . These can be visualized as points on the unit 2-sphere:

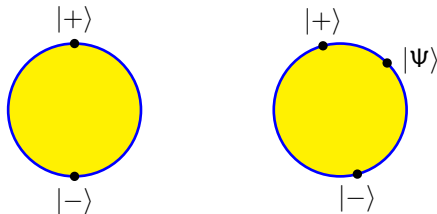

The Quantum Case: Spin Measurements

States of the system can be described by complex unit vectors in \mathbb{C}^2 . These can be visualized as points on the unit 2-sphere:

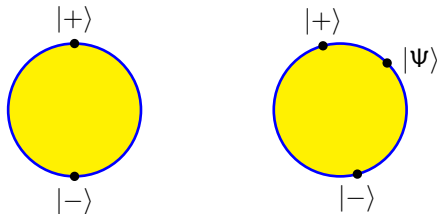

Spin can be measured in any direction; so there are a continuum of possible measurements. There are **two possible outcomes** for each such measurement; spin in the specified direction, or in the opposite direction. These two directions are represented by a pair of orthogonal vectors. They are represented on the sphere as a pair of **antipodal points**.

The Quantum Case: Spin Measurements

States of the system can be described by complex unit vectors in \mathbb{C}^2 . These can be visualized as points on the unit 2-sphere:

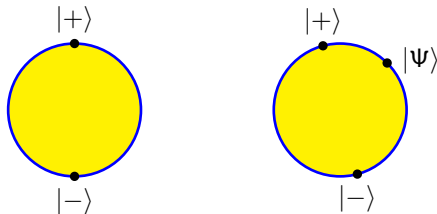

Spin can be measured in any direction; so there are a continuum of possible measurements. There are **two possible outcomes** for each such measurement; spin in the specified direction, or in the opposite direction. These two directions are represented by a pair of orthogonal vectors. They are represented on the sphere as a pair of **antipodal points**.

Note the appearance of **quantization** here: there are not a continuum of possible outcomes for each measurement, but only two!

The Stern-Gerlach Experiment

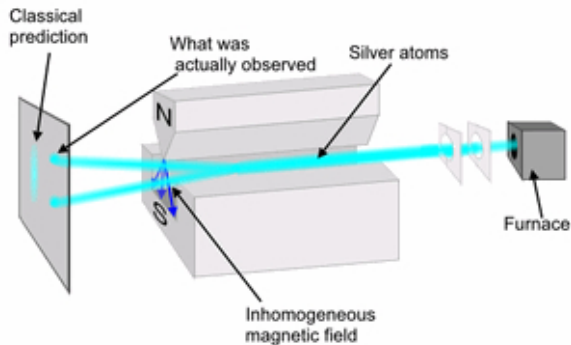

The Bloch sphere representation of qubits

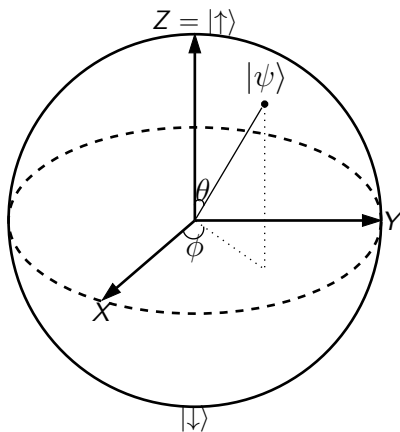

Properties of the Qubit

Note the following key features:

Properties of the Qubit

Note the following key features:

- States of the qubit are represented as points on the surface of the sphere.
Note that there are a continuum of possible states.

Properties of the Qubit

Note the following key features:

- States of the qubit are represented as points on the surface of the sphere. Note that there are a continuum of possible states.
- Each pair (Up, Down) of antipodal points on the sphere define a possible measurement that we can perform on the qubit. Each such measurement has two possible outcomes, corresponding to Up and Down in the given direction. We can think of this physically e.g. as measuring Spin Up or Spin Down in a given direction in space.

Properties of the Qubit

Note the following key features:

- States of the qubit are represented as points on the surface of the sphere. Note that there are a continuum of possible states.
- Each pair (Up, Down) of antipodal points on the sphere define a possible measurement that we can perform on the qubit. Each such measurement has two possible outcomes, corresponding to Up and Down in the given direction. We can think of this physically e.g. as measuring Spin Up or Spin Down in a given direction in space.
- When we subject a qubit to a measurement (Up, Down), the state of the qubit determines a probability distribution on the two possible outcomes. The probabilities are determined by the **angles** between the qubit state $|\psi\rangle$ and the points ($|\text{Up}\rangle, |\text{Down}\rangle$) which specify the measurement. In algebraic terms, $|\psi\rangle, |\text{Up}\rangle$ and $|\text{Down}\rangle$ are unit vectors in the complex vector space \mathbb{C}^2 , and the probability of observing Up when in state $|\psi\rangle$ is given by the square modulus of the inner product:

$$|\langle\psi|\text{Up}\rangle|^2.$$

This is known as the **Born rule**. It gives the basic predictive content of quantum mechanics.

Truth makes an angle with reality

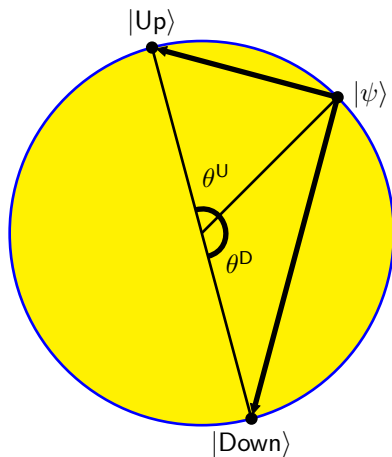

Qubits vs. Bits

Qubits vs. Bits

The sense in which the qubit generalises the classical bit is that, for each question we can ask — *i.e.* for each measurement — there are just two possible answers. We can view the states of the qubit as superpositions of the classical states 0 and 1, so that we have a probability of getting each of the answers for any given state.

Qubits vs. Bits

The sense in which the qubit generalises the classical bit is that, for each question we can ask — *i.e.* for each measurement — there are just two possible answers. We can view the states of the qubit as superpositions of the classical states 0 and 1, so that we have a probability of getting each of the answers for any given state.

But in addition, we have the important feature that there are a continuum of possible questions we can ask. However, note that on each run of the system, we can only ask **one** of these questions. We cannot simultaneously observe Up or Down in two different directions. Note that this corresponds to the feature of the scenario we discussed, that Alice and Bob could only look at one their local registers on each round.

Qubits vs. Bits

The sense in which the qubit generalises the classical bit is that, for each question we can ask — *i.e.* for each measurement — there are just two possible answers. We can view the states of the qubit as superpositions of the classical states 0 and 1, so that we have a probability of getting each of the answers for any given state.

But in addition, we have the important feature that there are a continuum of possible questions we can ask. However, note that on each run of the system, we can only ask **one** of these questions. We cannot simultaneously observe Up or Down in two different directions. Note that this corresponds to the feature of the scenario we discussed, that Alice and Bob could only look at one their local registers on each round.

Note in addition that a measurement has an **effect** on the state, which will no longer be the original state $|\psi\rangle$, but rather one of the states Up or Down, in accordance with the measured value.

Quantum Entanglement

Quantum Entanglement

Bell state:

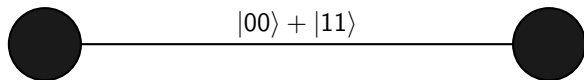

EPR state:

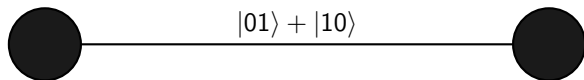

Quantum Entanglement

Bell state:

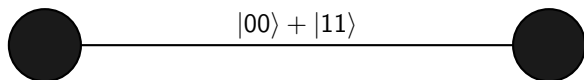

EPR state:

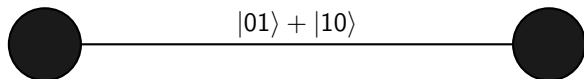

Compound systems are represented by **tensor product**: $\mathcal{H}_1 \otimes \mathcal{H}_2$. Typical element:

$$\sum_i \lambda_i \cdot \phi_i \otimes \psi_i$$

Superposition encodes **correlation**.

Quantum Entanglement

Bell state:

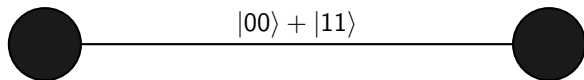

EPR state:

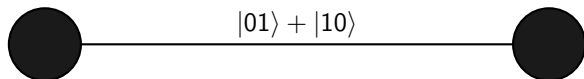

Compound systems are represented by **tensor product**: $\mathcal{H}_1 \otimes \mathcal{H}_2$. Typical element:

$$\sum_i \lambda_i \cdot \phi_i \otimes \psi_i$$

Superposition encodes **correlation**.

Einstein's 'spooky action at a distance'. Even if the particles are spatially separated, measuring one has an effect on the state of the other.

Quantum Entanglement

Bell state:

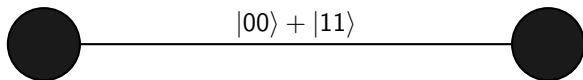

EPR state:

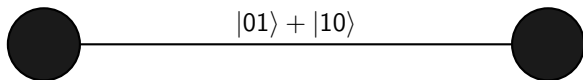

Compound systems are represented by **tensor product**: $\mathcal{H}_1 \otimes \mathcal{H}_2$. Typical element:

$$\sum_i \lambda_i \cdot \phi_i \otimes \psi_i$$

Superposition encodes **correlation**.

Einstein's 'spooky action at a distance'. Even if the particles are spatially separated, measuring one has an effect on the state of the other.

Bell's theorem: QM is **essentially non-local**.

A Probabilistic Model Of An Experiment

A Probabilistic Model Of An Experiment

Example: The Bell Model

A	B	(0,0)	(1,0)	(0,1)	(1,1)
a_1	b_1	$1/2$	0	0	$1/2$
a_1	b_2	$3/8$	$1/8$	$1/8$	$3/8$
a_2	b_1	$3/8$	$1/8$	$1/8$	$3/8$
a_2	b_2	$1/8$	$3/8$	$3/8$	$1/8$

A Probabilistic Model Of An Experiment

Example: The Bell Model

A	B	(0, 0)	(1, 0)	(0, 1)	(1, 1)
a_1	b_1	$1/2$	0	0	$1/2$
a_1	b_2	$3/8$	$1/8$	$1/8$	$3/8$
a_2	b_1	$3/8$	$1/8$	$1/8$	$3/8$
a_2	b_2	$1/8$	$3/8$	$3/8$	$1/8$

Important note: this is **physically realizable!**

A Probabilistic Model Of An Experiment

Example: The Bell Model

A	B	(0, 0)	(1, 0)	(0, 1)	(1, 1)
a_1	b_1	1/2	0	0	1/2
a_1	b_2	3/8	1/8	1/8	3/8
a_2	b_1	3/8	1/8	1/8	3/8
a_2	b_2	1/8	3/8	3/8	1/8

Important note: this is **physically realizable!**

Generated by Bell state

$$\frac{|00\rangle + |11\rangle}{\sqrt{2}},$$

subjected to measurements in the XY -plane, at relative angle $\pi/3$.

A Probabilistic Model Of An Experiment

Example: The Bell Model

A	B	(0, 0)	(1, 0)	(0, 1)	(1, 1)
a_1	b_1	1/2	0	0	1/2
a_1	b_2	3/8	1/8	1/8	3/8
a_2	b_1	3/8	1/8	1/8	3/8
a_2	b_2	1/8	3/8	3/8	1/8

Important note: this is **physically realizable!**

Generated by Bell state

$$\frac{|00\rangle + |11\rangle}{\sqrt{2}},$$

subjected to measurements in the XY -plane, at relative angle $\pi/3$.

Extensively tested experimentally.

Computing the Bell table

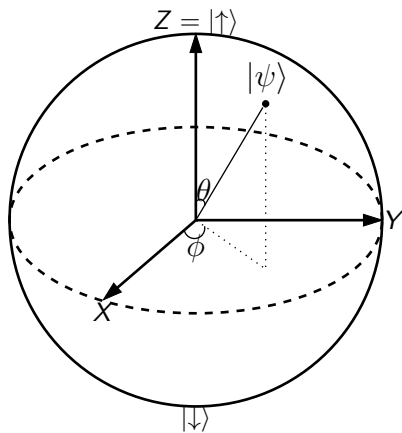

Computing the Bell table

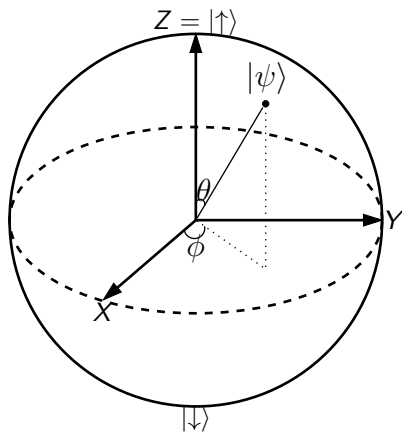

Spin measurements lying in the equatorial plane of the Bloch sphere
Spin Up: $(|\uparrow\rangle + e^{i\phi}|\downarrow\rangle)/\sqrt{2}$, Spin Down: $(|\uparrow\rangle + e^{i(\phi+\pi)}|\downarrow\rangle)/\sqrt{2}$

Computing the Bell table

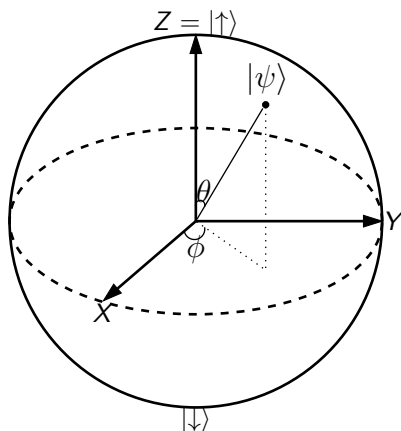

Spin measurements lying in the equatorial plane of the Bloch sphere

Spin Up: $(|\uparrow\rangle + e^{i\phi}|\downarrow\rangle)/\sqrt{2}$, Spin Down: $(|\uparrow\rangle + e^{i(\phi+\pi)}|\downarrow\rangle)/\sqrt{2}$

X itself, $\phi = 0$:

Spin Up $(|\uparrow\rangle + |\downarrow\rangle)/\sqrt{2}$ and Spin Down $(|\uparrow\rangle - |\downarrow\rangle)/\sqrt{2}$.

Computing the Bell table

Computing the Bell table

A	B	(0,0)	(1,0)	(0,1)	(1,1)
a	b	0	$1/2$	$1/2$	0
a'	b	$3/8$	$1/8$	$1/8$	$3/8$
a	b'	$3/8$	$1/8$	$1/8$	$3/8$
a'	b'	$3/8$	$1/8$	$1/8$	$3/8$

Computing the Bell table

A	B	(0,0)	(1,0)	(0,1)	(1,1)
a	b	0	$1/2$	$1/2$	0
a'	b	$3/8$	$1/8$	$1/8$	$3/8$
a	b'	$3/8$	$1/8$	$1/8$	$3/8$
a'	b'	$3/8$	$1/8$	$1/8$	$3/8$

Alice: $a = X$, a' at $\phi = \pi/3$ (on **first** qubit)

Bob: $b = X$, b' at $\phi = \pi/3$ (on **second** qubit)

Computing the Bell table

A	B	(0, 0)	(1, 0)	(0, 1)	(1, 1)
a	b	0	1/2	1/2	0
a'	b	3/8	1/8	1/8	3/8
a	b'	3/8	1/8	1/8	3/8
a'	b'	3/8	1/8	1/8	3/8

Alice: $a = X$, a' at $\phi = \pi/3$ (on **first** qubit)

Bob: $b = X$, b' at $\phi = \pi/3$ (on **second** qubit)

The event in yellow is represented by

$$\frac{|\uparrow\rangle + |\downarrow\rangle}{\sqrt{2}} \otimes \frac{|\uparrow\rangle + e^{i4\pi/3}|\downarrow\rangle}{\sqrt{2}} = \frac{|\uparrow\uparrow\rangle + e^{i4\pi/3}|\uparrow\downarrow\rangle + |\downarrow\uparrow\rangle + e^{i4\pi/3}|\downarrow\downarrow\rangle}{2}.$$

Computing the Bell table

A	B	(0, 0)	(1, 0)	(0, 1)	(1, 1)
a	b	0	1/2	1/2	0
a'	b	3/8	1/8	1/8	3/8
a	b'	3/8	1/8	1/8	3/8
a'	b'	3/8	1/8	1/8	3/8

Alice: $a = X$, a' at $\phi = \pi/3$ (on **first** qubit)

Bob: $b = X$, b' at $\phi = \pi/3$ (on **second** qubit)

The event in yellow is represented by

$$\frac{|\uparrow\rangle + |\downarrow\rangle}{\sqrt{2}} \otimes \frac{|\uparrow\rangle + e^{i4\pi/3}|\downarrow\rangle}{\sqrt{2}} = \frac{|\uparrow\uparrow\rangle + e^{i4\pi/3}|\uparrow\downarrow\rangle + |\downarrow\uparrow\rangle + e^{i4\pi/3}|\downarrow\downarrow\rangle}{2}.$$

Probability of this event M when measuring (a, b') on $B = (|\uparrow\uparrow\rangle + |\downarrow\downarrow\rangle)/\sqrt{2}$ is given by Born rule:

$$|\langle B|M\rangle|^2.$$

Computing Bell by Born

Computing Bell by Born

Since the vectors $|\uparrow\uparrow\rangle, |\uparrow\downarrow\rangle, |\downarrow\uparrow\rangle, |\downarrow\downarrow\rangle$ are pairwise orthogonal, $|\langle B|M\rangle|^2$ simplifies to

$$\left| \frac{1 + e^{i4\pi/3}}{2\sqrt{2}} \right|^2 = \frac{|1 + e^{i4\pi/3}|^2}{8}.$$

Computing Bell by Born

Since the vectors $|\uparrow\uparrow\rangle$, $|\uparrow\downarrow\rangle$, $|\downarrow\uparrow\rangle$, $|\downarrow\downarrow\rangle$ are pairwise orthogonal, $|\langle B|M\rangle|^2$ simplifies to

$$\left| \frac{1 + e^{i4\pi/3}}{2\sqrt{2}} \right|^2 = \frac{|1 + e^{i4\pi/3}|^2}{8}.$$

Using the Euler identity $e^{i\theta} = \cos\theta + i\sin\theta$, we have

$$|1 + e^{i\theta}|^2 = 2 + 2\cos\theta.$$

Computing Bell by Born

Since the vectors $|\uparrow\uparrow\rangle$, $|\uparrow\downarrow\rangle$, $|\downarrow\uparrow\rangle$, $|\downarrow\downarrow\rangle$ are pairwise orthogonal, $|\langle B|M\rangle|^2$ simplifies to

$$\left| \frac{1 + e^{i4\pi/3}}{2\sqrt{2}} \right|^2 = \frac{|1 + e^{i4\pi/3}|^2}{8}.$$

Using the Euler identity $e^{i\theta} = \cos\theta + i\sin\theta$, we have

$$|1 + e^{i\theta}|^2 = 2 + 2\cos\theta.$$

Hence

$$\frac{|1 + e^{i4\pi/3}|^2}{8} = \frac{2 + 2\cos(4\pi/3)}{8} = \frac{1}{8}.$$

Computing Bell by Born

Since the vectors $|\uparrow\uparrow\rangle$, $|\uparrow\downarrow\rangle$, $|\downarrow\uparrow\rangle$, $|\downarrow\downarrow\rangle$ are pairwise orthogonal, $|\langle B|M\rangle|^2$ simplifies to

$$\left| \frac{1 + e^{i4\pi/3}}{2\sqrt{2}} \right|^2 = \frac{|1 + e^{i4\pi/3}|^2}{8}.$$

Using the Euler identity $e^{i\theta} = \cos\theta + i\sin\theta$, we have

$$|1 + e^{i\theta}|^2 = 2 + 2\cos\theta.$$

Hence

$$\frac{|1 + e^{i4\pi/3}|^2}{8} = \frac{2 + 2\cos(4\pi/3)}{8} = \frac{1}{8}.$$

The other entries can be computed similarly.